

FRONT ELEVATION

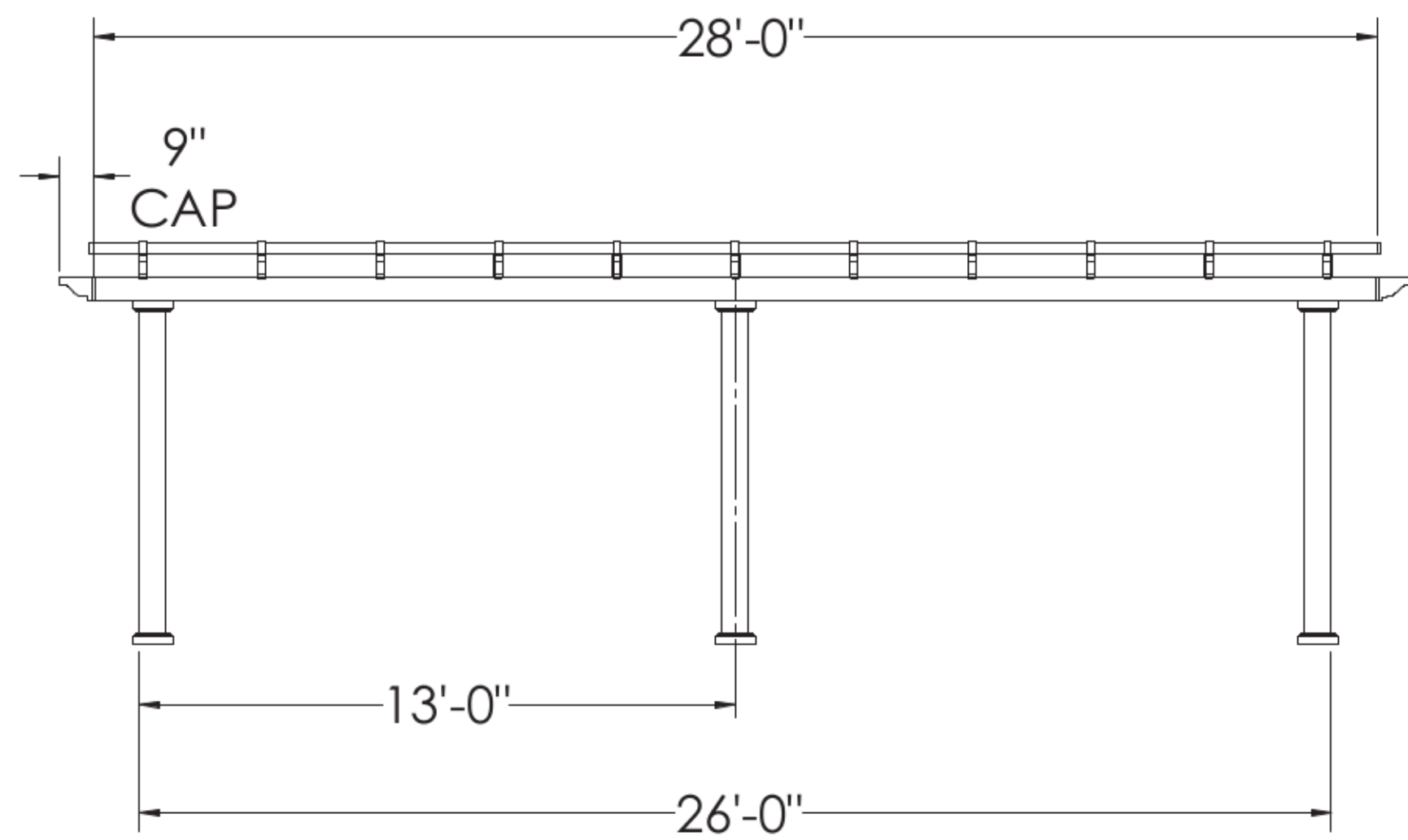

Post on Center Measurement

5" Square Post	307"
7" Square Column	301 1/2"
7" Round Column	301 1/2"
10" Round Column	299 3/4"

SIDE ELEVATION

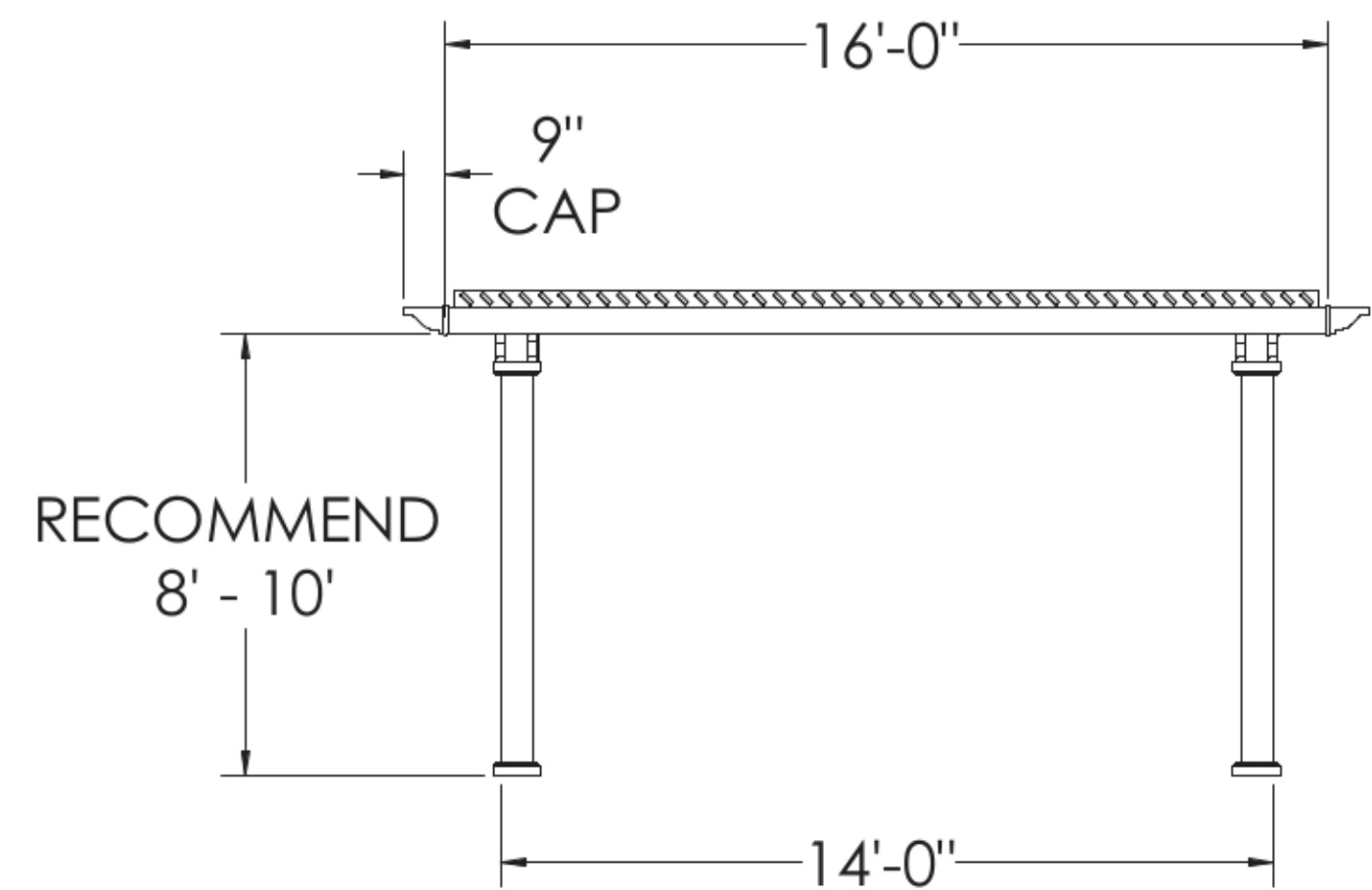

Center of Post to Structure Measurement

5" Square Post	163"
7" Square Column	157 1/2"
7" Round Column	157 1/2"
10" Round Column	155 3/4"

16' x 28' FREESTANDING PERGOLA

SunsetPergolaKits.com

1-800-430-1690



PLAN VIEW

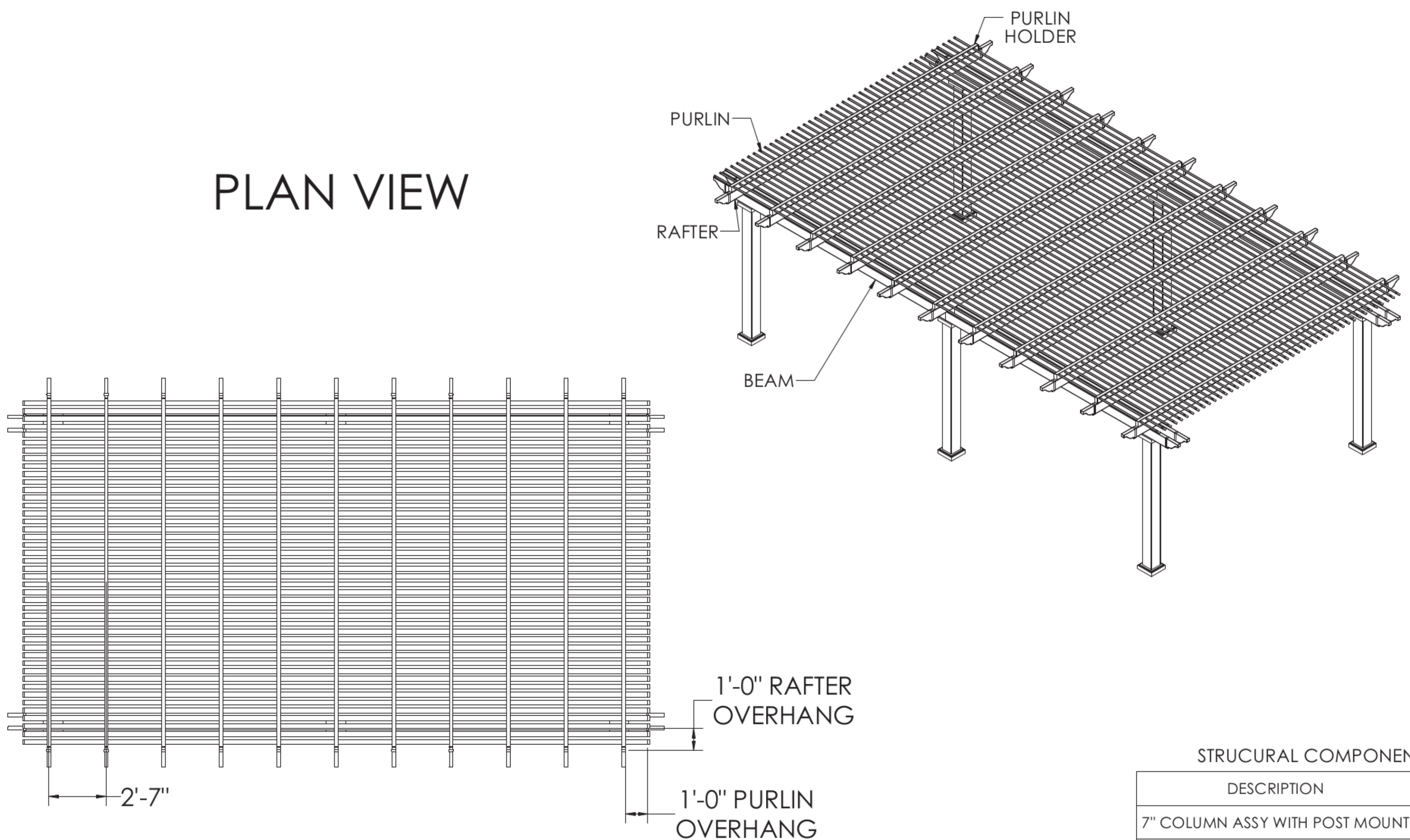

STRUCTURAL COMPONENTS

DESCRIPTION	QTY.
7" COLUMN ASSY WITH POST MOUNT	6
2 x 6 BEAM WITH ALUMINUM INSERT	8
2 x 6 RAFTER WITH ALUMINUM INSERT	11
2 x 6 PERGOLA CAP	30
2 x 3 1/2 PURLIN HOLDER	11
2 x 3 1/2 FLAT CAP	22
7/8 x 3 PURLIN (STD SPACING)	44
7/8 x 3 PURLIN CAP (STD SPACING)	88

16' x 28' FREESTANDING PERGOLA

SunsetPergolaKits.com

1-800-430-1690

