

FRONT ELEVATION

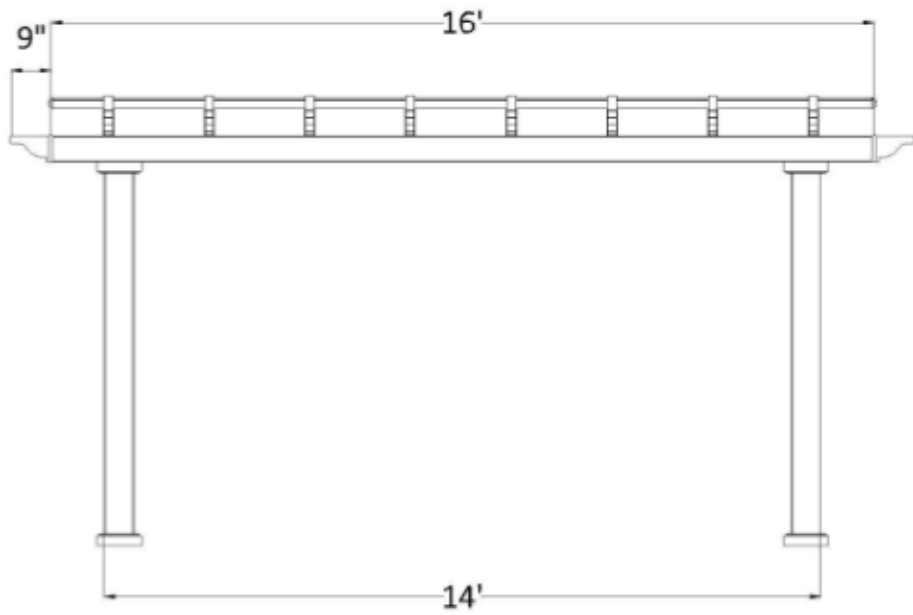

Post on Center Measurement

5" Square Post	163"
7" Square Column	157 1/2"
8" Round Column	157 1/2"
10" Round Column	155 3/4"

SIDE ELEVATION

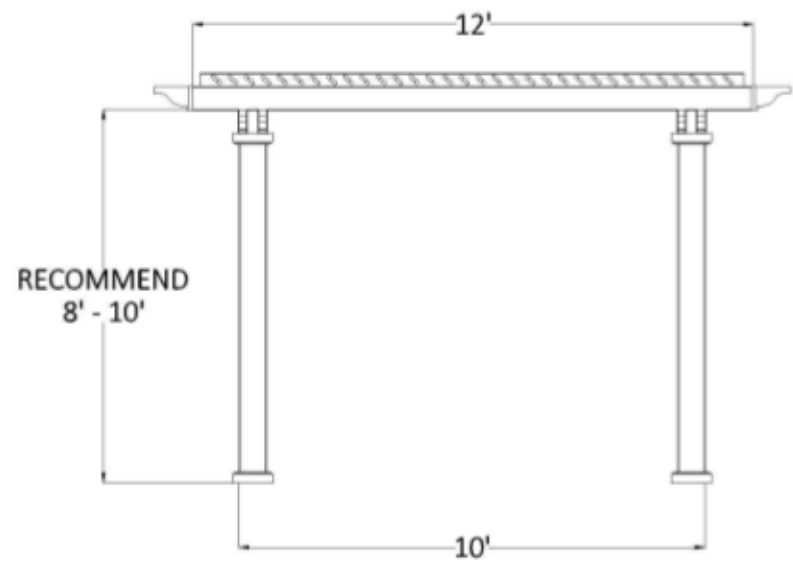

Center of Post to Structure Measurement

5" Square Post	127"
7" Square Column	121 1/2"
7" Round Column	121 1/2"
10" Round Column	119 3/4"

12' x 16' FREESTANDING PERGOLA

SunsetPergolaKits.com

1-800-430-1690



PLAN VIEW

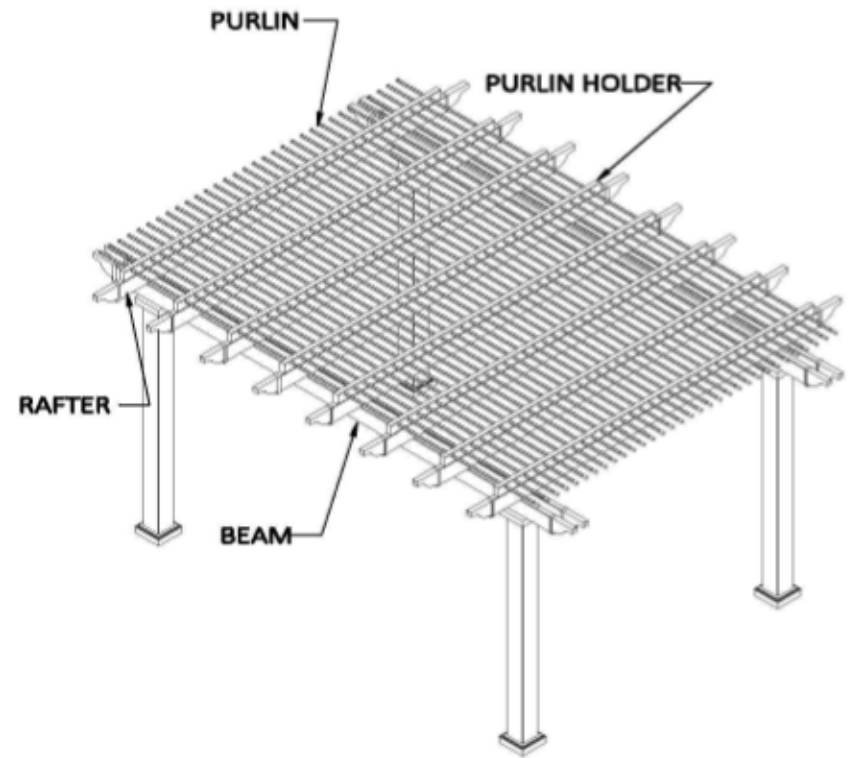
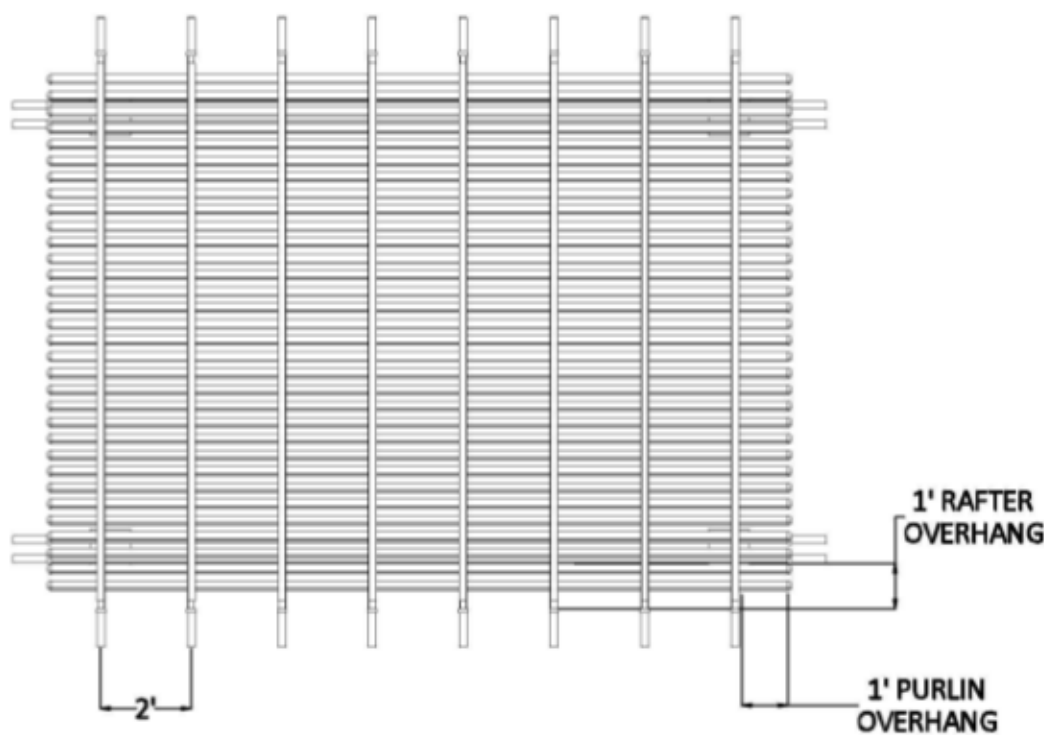

STRUCTURAL COMPONENTS

DESCRIPTION	QTY.
7" COLUMN ASSEMBLY W POST MOUNT	4
2 X 6 BEAM WITH ALUMINUM INSERT	4
2 X 6 RAFTER WITH ALUMINUM INSERT	8
2 X 6 PERGOLA CAP	24
2 X 3 1/2" PURLIN HOLDER	8
2 X 3 1/2" FLAT CAP	16
3/4" X 3" PURLIN (STD SPACING)	32
3/4" X 3" PURLIN CAP	64

12' x 16' FREESTANDING PERGOLA

SunsetPergolaKits.com

1-800-430-1690

