

FRONT ELEVATION

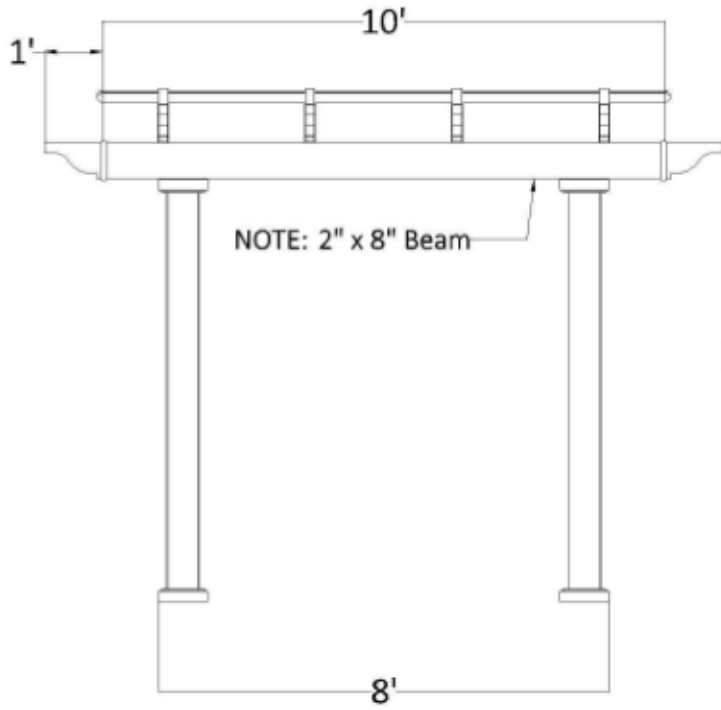

Post On Center Measurement

5" Square Post	91"
7" Square Column	85 1/2"
7" Round Column	85 1/2"
10" Round Column	83 3/4"

SIDE ELEVATION

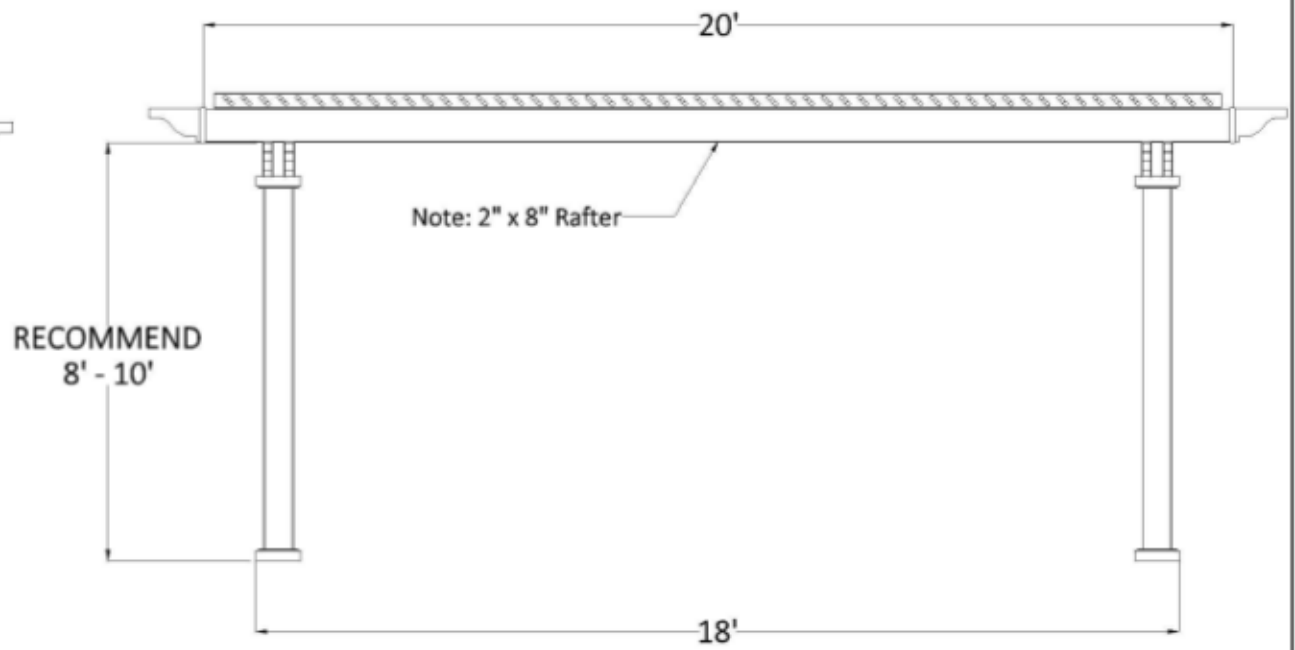

Post On Center Measurement

5" Square Post	211"
7" Square Column	205 1/2"
7" Round Column	205 1/2"
10" Round Column	203 3/4"

20' x 10' FREESTANDING PERGOLA

SunsetPergolaKits.com

800-430-1690



PLAN VIEW

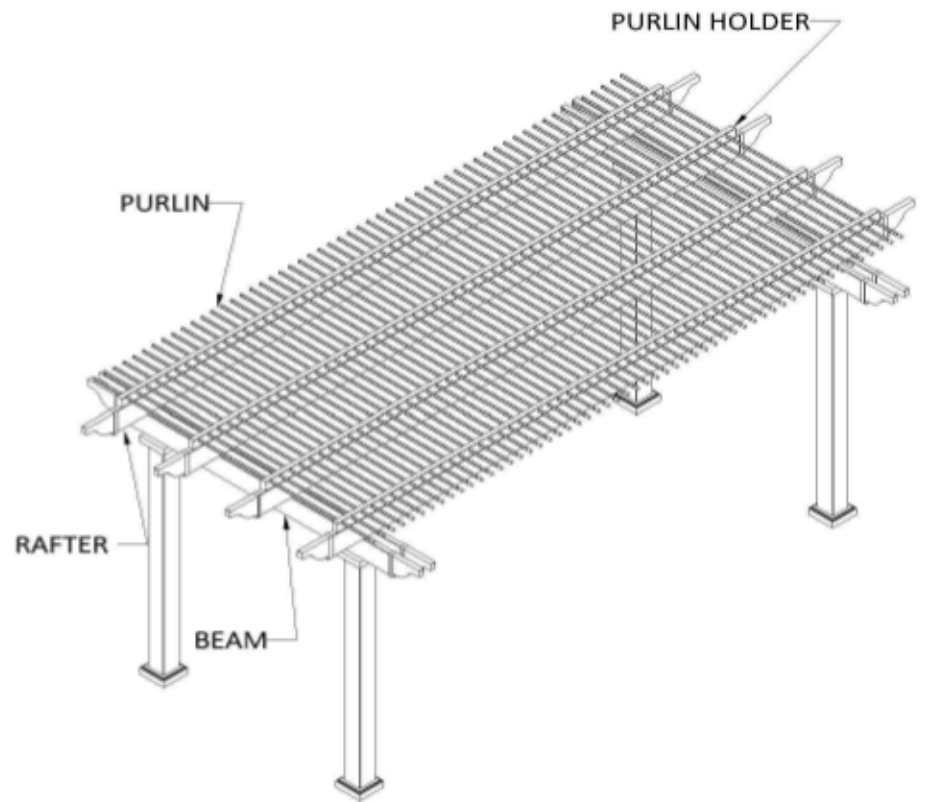
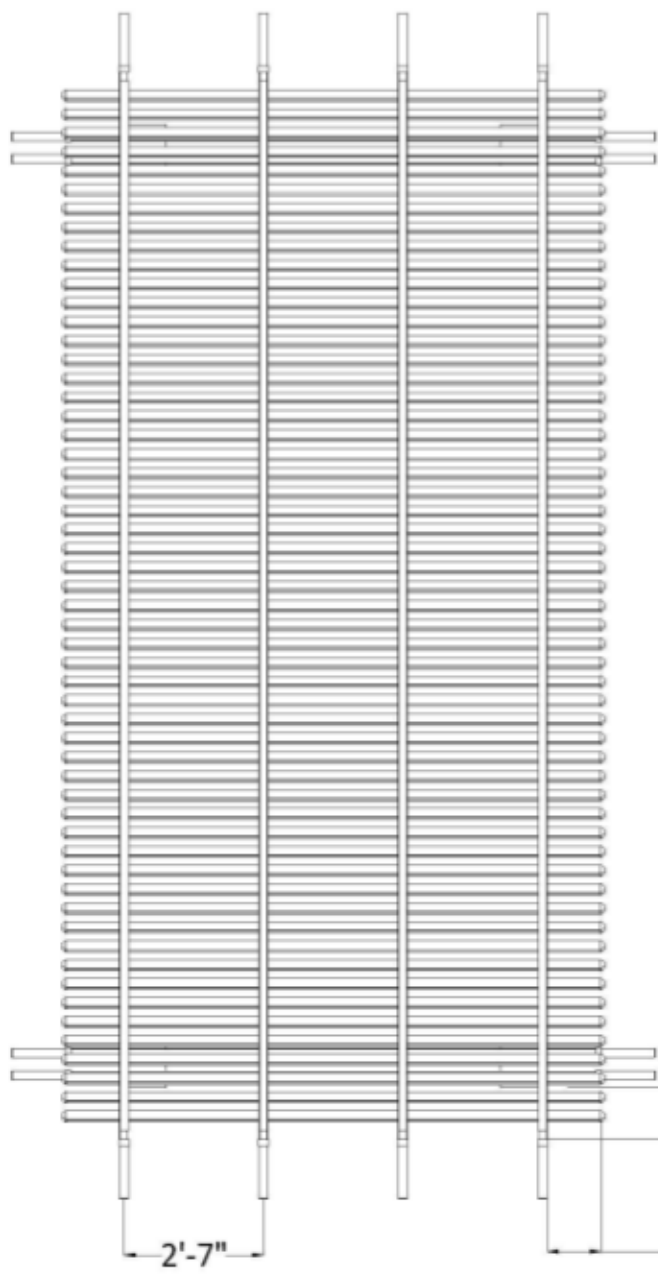

STRUCTURAL COMPONENTS

DESCRIPTION	QTY.
7" COLUMN ASSEMBLY W POST MOUNT	4
2 X 8 BEAM WITH ALUMINUM INSERT	4
2 X 8 RAFTER WITH ALUMINUM INSERT	4
2 X 8 PERGOLA CAP	16
2 X 3 1/2 PURLIN HOLDER	4
2 X 3 1/2 FLAT CAP	8
3/4 X 3 PURLIN (STD SPACING)	55
3/4 X 3 PURLIN CAP	110

20' x 10' FREESTANDING PERGOLA

SunsetPergolaKits.com

800-430-1690

