

FRONT ELEVATION

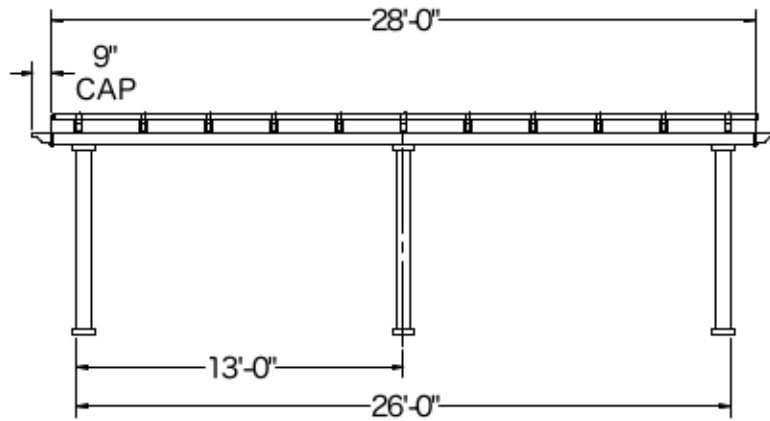

Post on Center Measurement

5" Square Post	307"
7" Square Column	301 1/2"
7" Round Column	301 1/2"
10" Round Column	299 3/4"

SIDE ELEVATION

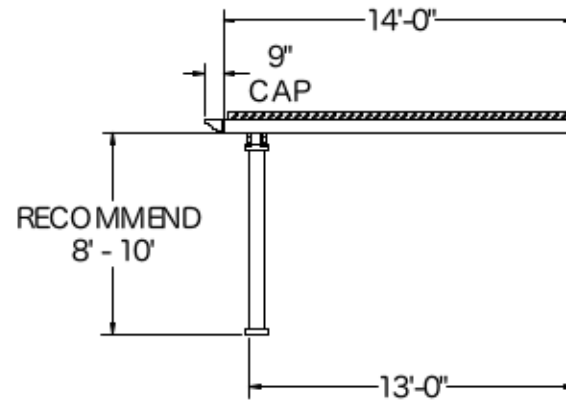

Center of Post to Structure Measurement

5" Square Post	153 1/2"
7" Square Column	150 3/4"
7" Round Column	150 3/4"
10" Round Column	149 7/8"

14' x 28' ATTACHED PERGOLA

SunsetPergolaKits.com

1-800-430-1690

Sunset
PERGOLA KITS

PLAN VIEW

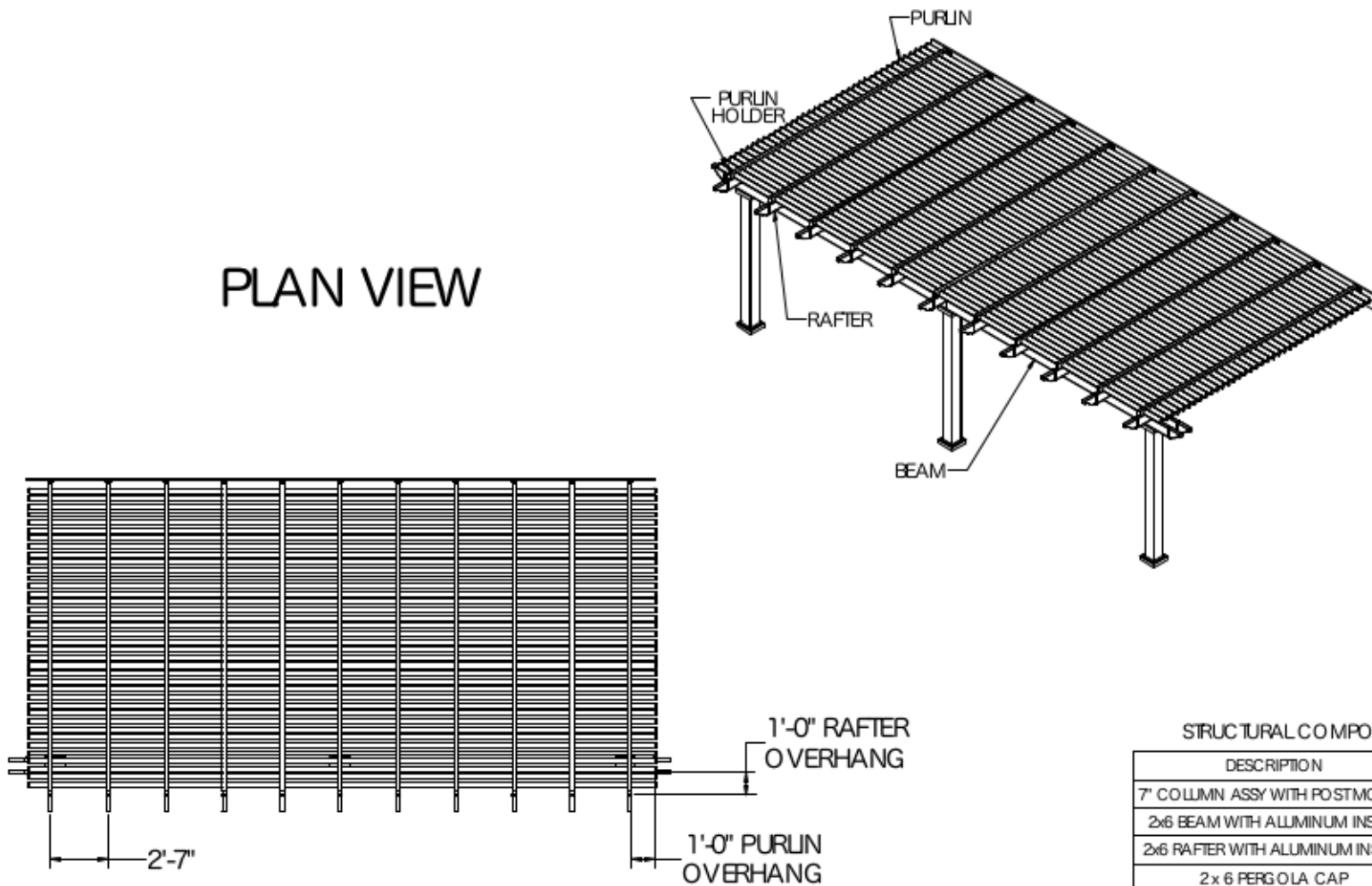

STRUCTURAL COMPONENTS

DESCRIPTION	QTY.
7" COLUMN ASSY WITH POSTMOUNT	3
2x6 BEAM WITH ALUMINUM INSERT	4
2x6 RAFTER WITH ALUMINUM INSERT	11
2x6 PERGOLA CAP	15
RAFTER HANGER WITH COVER	11
2x3 1/2 PURLIN HOLDER	11
2x3 1/2 FLATCAP	22
7/8x3 PURLIN (STD SPACING)	38
7/8x3 PURLIN CAP (STD SPACING)	76
PVC LEDGER PLATE	1

14' x 28' ATTACHED PERGOLA

SunsetPergolaKits.com

1-800-430-1690

Sunset
PERGOLA KITS