

## FRONT ELEVATION

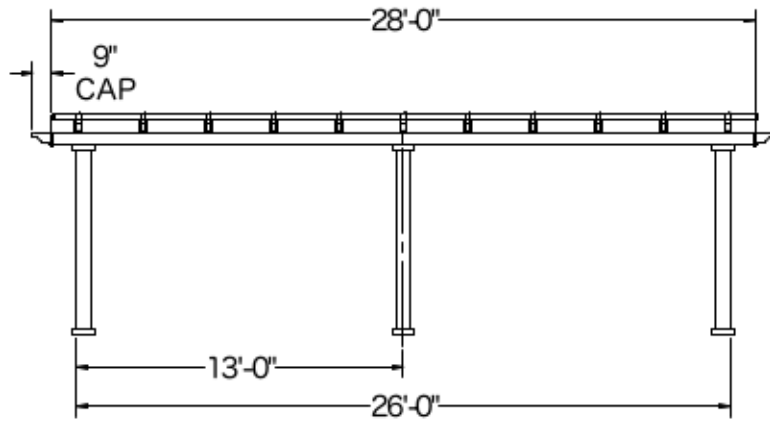

### Post on Center Measurement

5" Square Post	307"
7" Square Column	301 1/2"
7" Round Column	301 1/2"
10" Round Column	299 3/4"

## SIDE ELEVATION

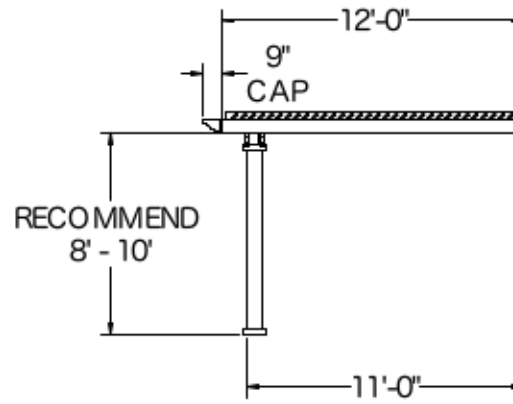

### Center of Post to Structure Measurement

5" Square Post	129 1/2"
7" Square Column	126 3/4"
7" Round Column	126 3/4"
10" Round Column	125 7/8"

12' x 28' ATTACHED PERGOLA

SunsetPergolaKits.com

1-800-430-1690

Sunset  
**PERGOLA KITS**

## PLAN VIEW

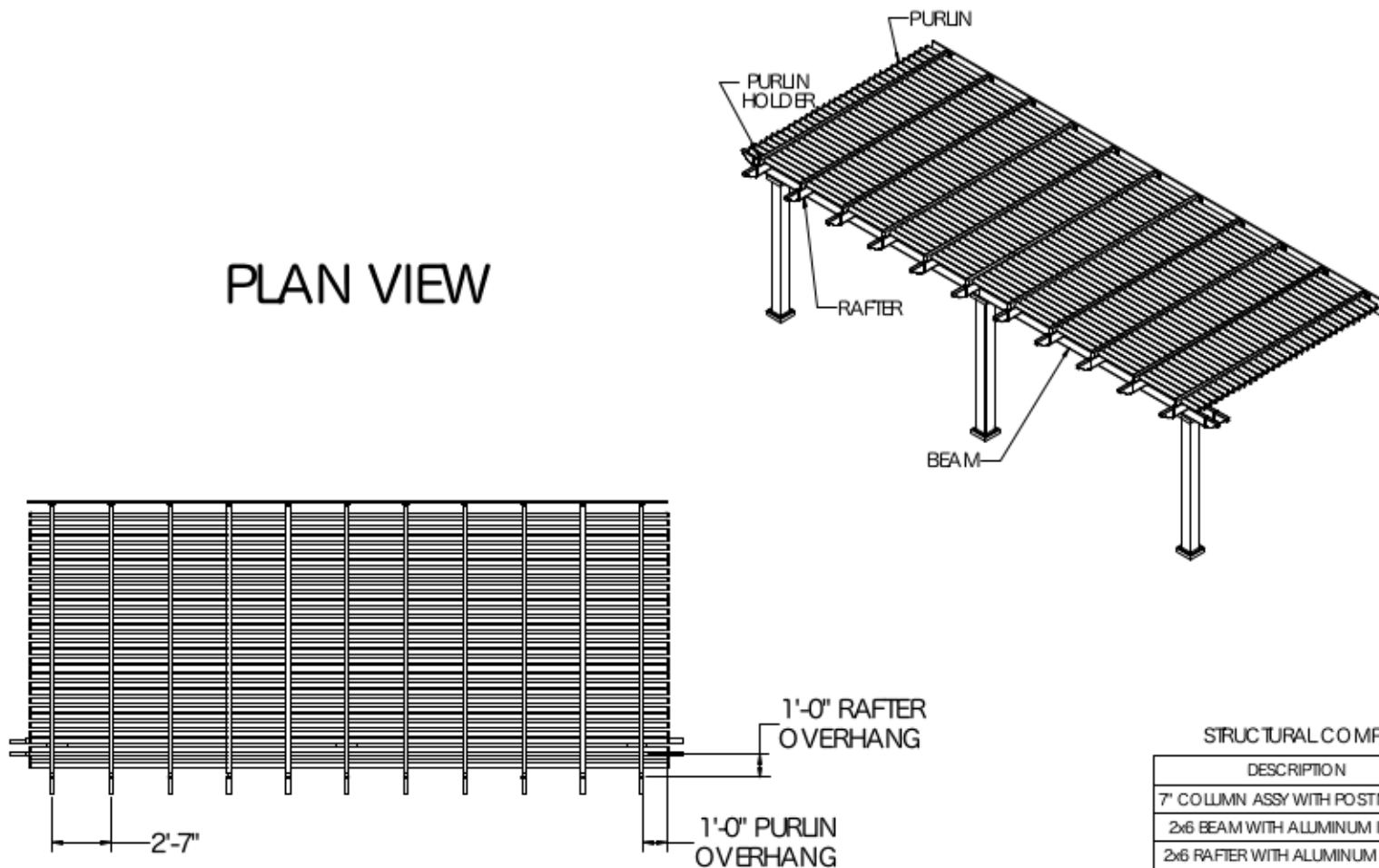

### STRUCTURAL COMPONENTS

DESCRIPTION	QTY.
7" COLUMN ASSY WITH POSTMOUNT	3
2x6 BEAM WITH ALUMINUM INSERT	4
2x6 RAFTER WITH ALUMINUM INSERT	11
2x6 PERGOLA CAP	15
RAFTER HANGER WITH COVER	11
2x3 1/2 PURLIN HOLDER	11
2x3 1/2 RAFT CAP	22
7/8x3 PURLIN (STD SPACING)	32
7/8x3 PURLIN CAP (STD SPACING)	64
PVC LEDGER PLATE	1

12' x 28' ATTACHED PERGOLA

SunsetPergolaKits.com

1-800-430-1690

Sunset  
**PERGOLA KITS**