

FRONT ELEVATION

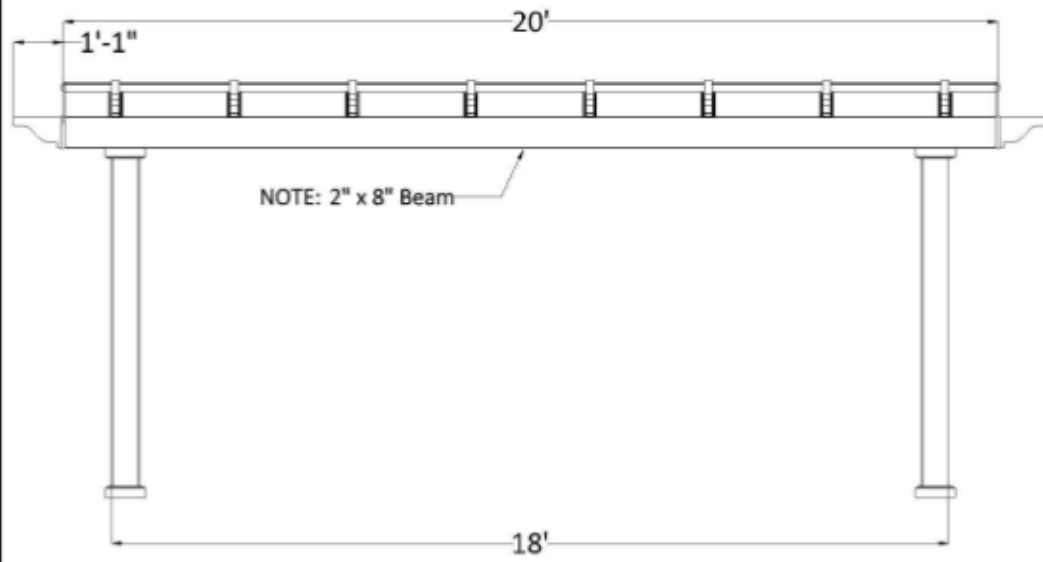

Post on Center Measurement

5" Square Post	211"
7" Square Column	205 1/2"
7" Round Column	205 1/2"
10" Round Column	203 3/4"

SIDE ELEVATION

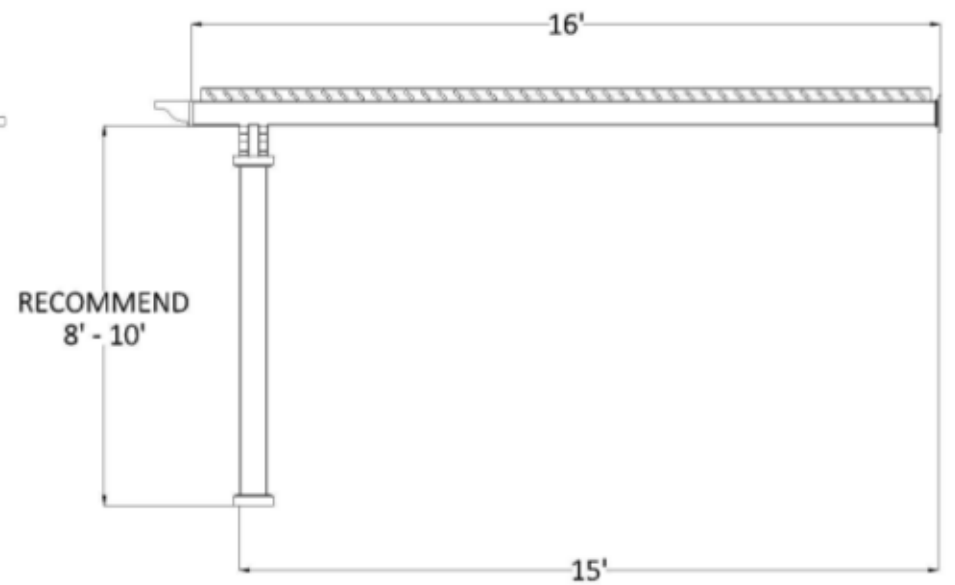

Center of Post to Structure Measurement

5" Square Post	177 1/2"
7" Square Column	174 3/4"
7" Round Column	174 3/4"
10" Round Column	173 7/8"

16' x 20' ATTACHED PERGOLA

SunsetPergolaKits.com

1-800-430-1690



PLAN VIEW

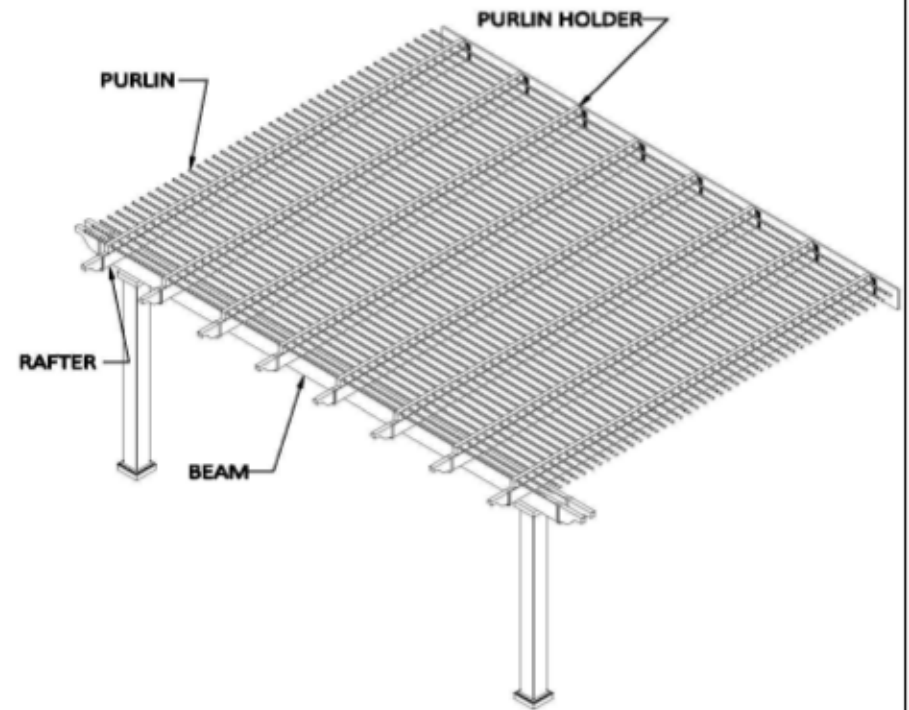
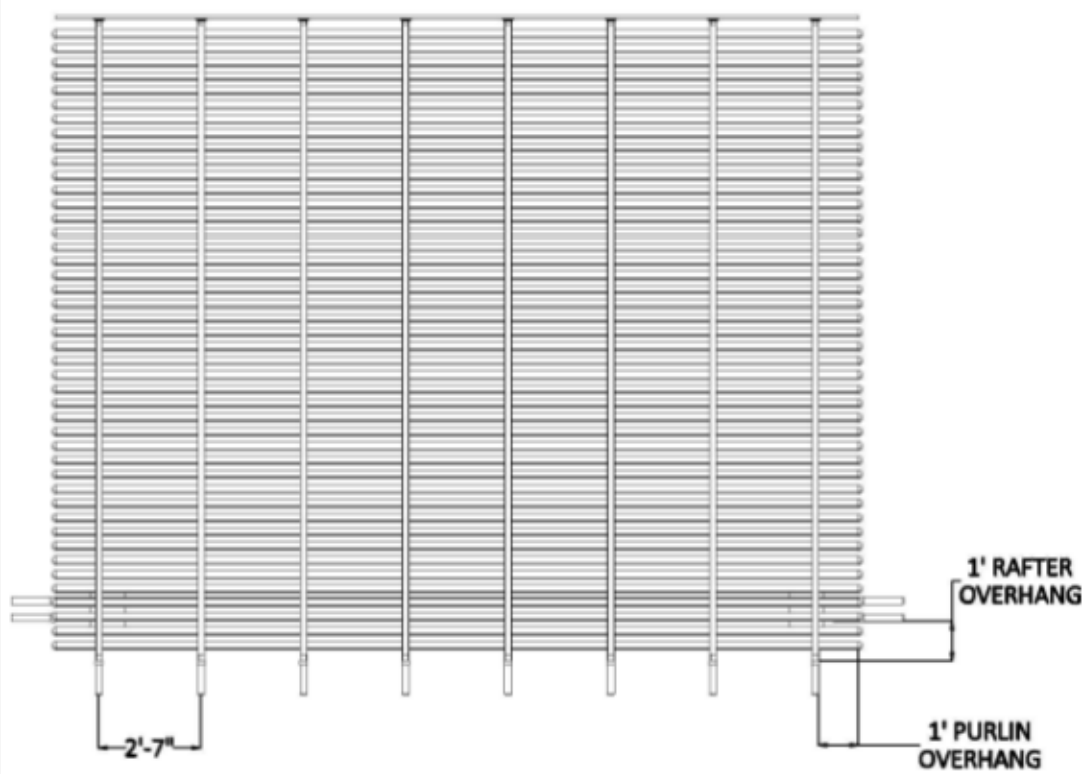

STRUCTURAL COMPONENTS

DESCRIPTION	QTY.
7" COLUMN ASSEMBLY W POST MOUNT	2
2 X 8 BEAM WITH ALUMINUM INSERT	2
2 X 6 RAFTER WITH ALUMINUM INSERT	8
PERGOLA CAP	12
2 X 3 1/2 PURLIN HOLDER	8
2 X 3 1/2 FLAT CAP	16
3/4 X 3 PURLIN (STD SPACING)	44
3/8 X 3 PURLIN CAP	88
PVC LEDGER PLATE	1

16' x 20' ATTACHED PERGOLA

SunsetPergolaKits.com

1-800-430-1690

