

FRONT ELEVATION

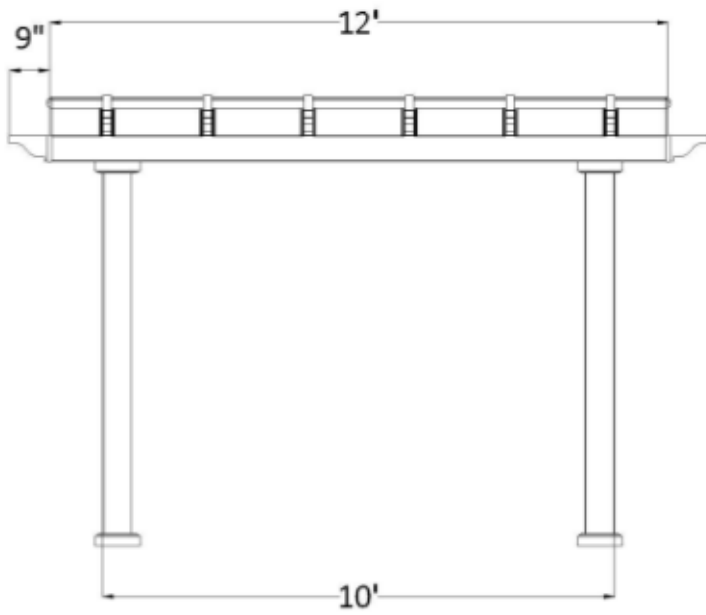

Post on Center Measurement

5" Square Post	115"
7" Square Column	109 1/2"
7" Round Column	109 1/2"
10" Round Column	107 3/4"

SIDE ELEVATION

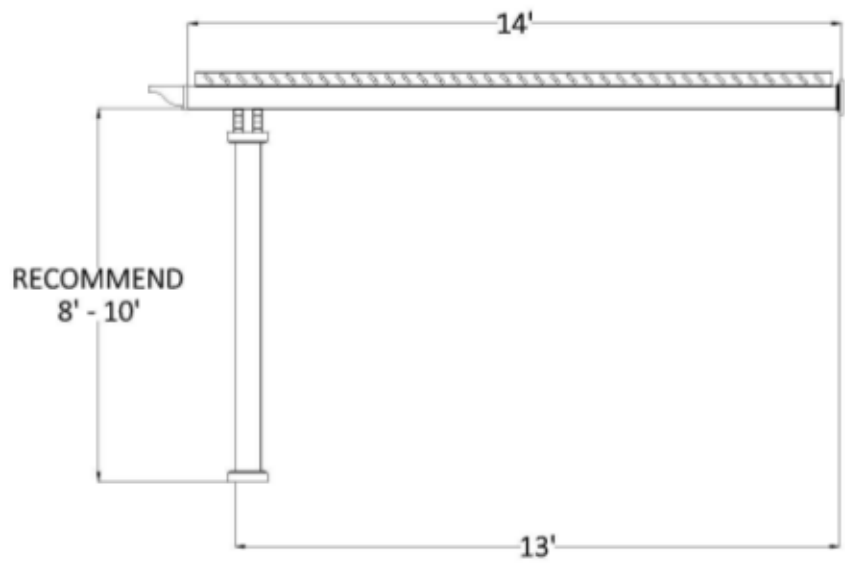

Center of Post to Structure Measurement

5" Square Post	153 1/2"
7" Square Column	150 3/4"
7" Round Column	150 3/4"
10" Round Column	149 7/8"

14' x 12' ATTACHED PERGOLA

SunsetPergolaKits.com

1-800-430-1690



PLAN VIEW

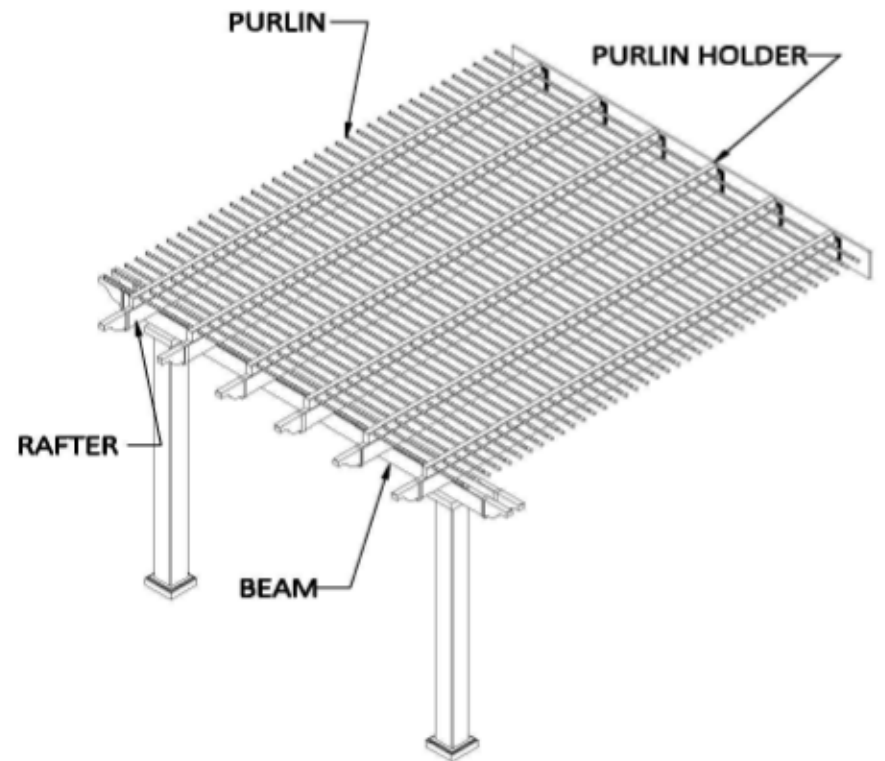
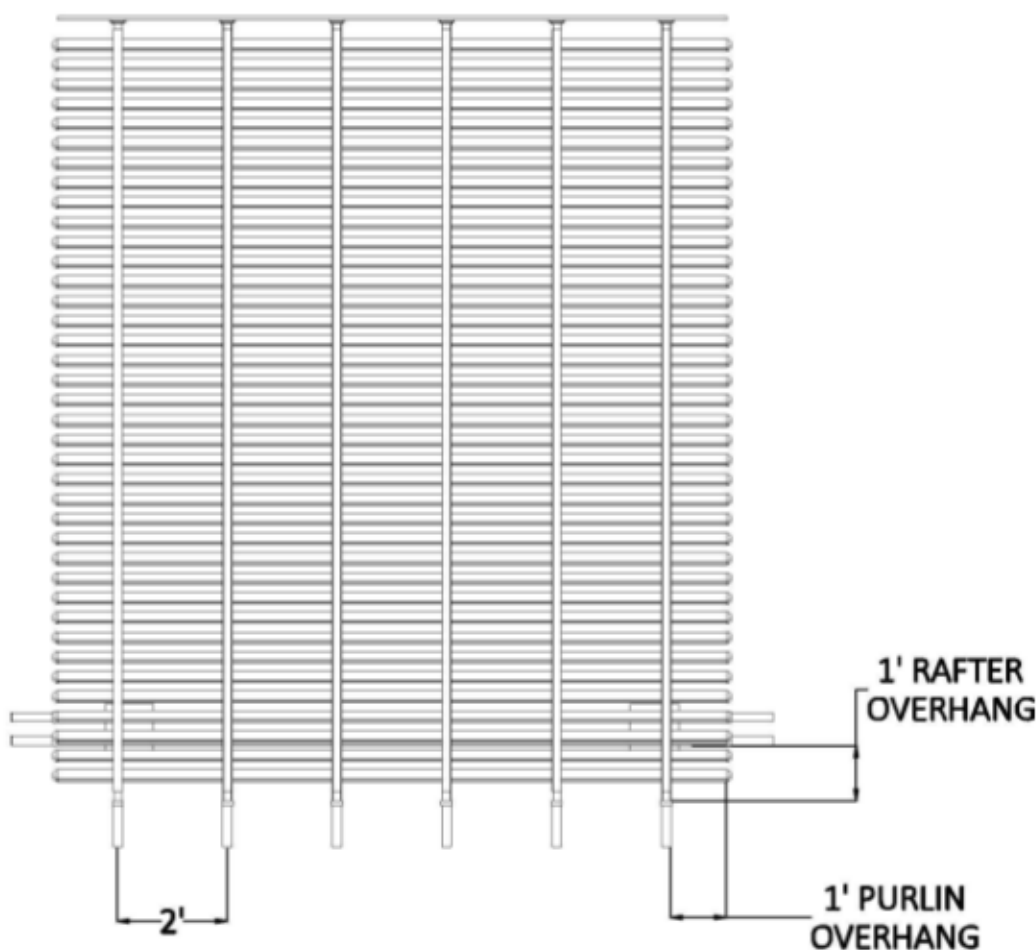

STRUCTURAL COMPONENTS

DESCRIPTION	QTY.
7" COLUMN ASSEMBLY W POST MOUNT	2
2 X 6 BEAM WITH ALUMINUM INSERT	2
2 X 6 RAFTER WITH ALUMINUM INSERT	6
2 X 6 PERGOLA CAP	10
2 X 3 1/2 PURLIN HOLDER	6
2 X 3 1/2 FLAT CAP	12
3/8 X 3 PURLIN (STD SPACING)	38
7/8 X 3 PURLIN CAP	76
PVC LEDGER PLATE	1

14' x 12' ATTACHED PERGOLA

SunsetPergolaKits.com

1-800-430-1690

